

Varenummer: 2969100083
Beskrivelse: Flange type C for gear A10./F10.

Mål

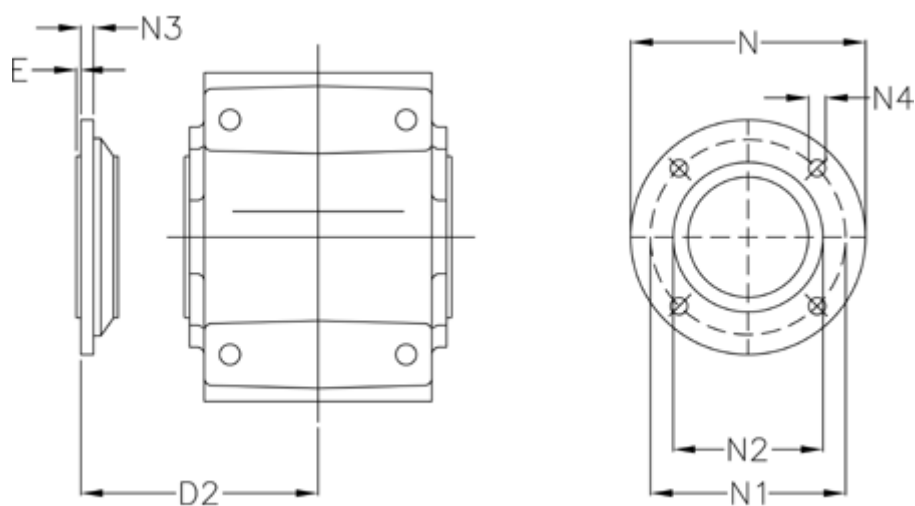

Betegnelse = Flange C for A10.

D2 = 91.5

E = 4.0

N = 250

N1 = 215

N2 = 180

N3 = 13

N4 = 14